

**CLAS**<sup>®</sup>

*Selection*  
**WINTER**

FROM JANUARY 1<sup>ST</sup> TO MARCH 31<sup>ST</sup> 2025



# Selection WINTER

TN

## DOUBLE HEADBAND HEADLAMP

OE 0199BL

**B.LINE**  
BUDGET SOLUTION

+ Light and powerful

Buy x1

12 €VAT Excl.\*

Buy x12

10 €VAT Excl.

Instead of 23 €VAT Excl.\*

The unit

Hands-free sensor



2 MODES  
100%/50%

2 MODES  
100%/50%

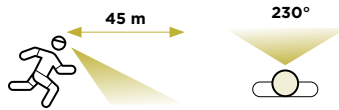

## WORKSHOP HAND LAMP

OE 0099BL

**B.LINE**  
BUDGET SOLUTION

TN

Buy x1

16 €VAT Excl.\*

Buy x12

14 €VAT Excl.

Instead of 23 €VAT Excl.\*

The unit



Overhead lighting



Pocket clip and hook

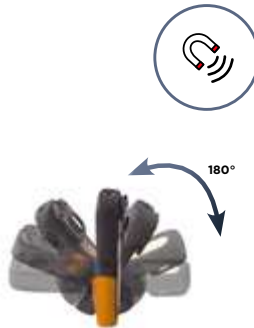
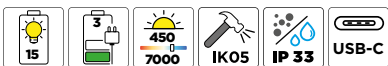

164 mm



## MINI HAND LAMP

OE 0299

TN

22 €VAT Excl.

Instead of 23 €VAT Excl.\*

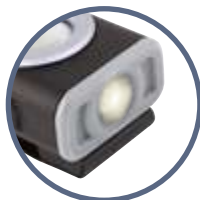

Overhead lighting

+ Pen format, fits in your pocket!

97 mm

2 MODES  
100%/50%



TN

**ULTRATHIN CORDLESS RECHARGEABLE LAMP WITH VARIABLE INTENSITY**

OE 0145BL

**B.LINE**  
BUDGET SOLUTION

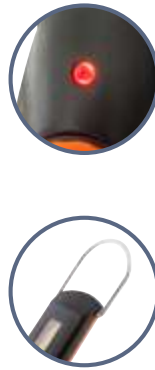

377 mm

**17,90** €VAT Excl.

Instead of 19,90 €VAT Excl.\*



**ULTRATHIN CORDLESS RECHARGEABLE LAMP WITH VARIABLE INTENSITY 7W IK07**

OE 0143



385 mm

**59** €VAT Excl.

Instead of 65 €VAT Excl.\*

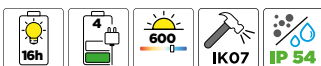

Dimmer switch



**EXTRA-FLAT INSPECTION LAMP**

OE 0399

**+** Ultra-thin! Only 10mm thick

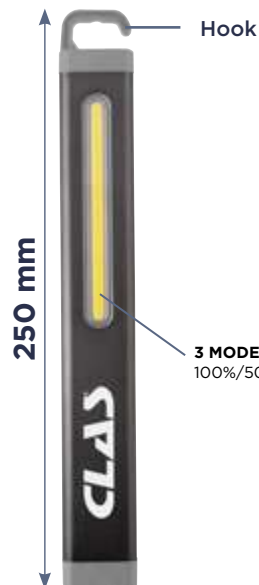

250 mm

Hook

**3 MODES**  
100%/50%/Flash



10mm

**33** €VAT Excl.

Instead of 35 €VAT Excl.\*

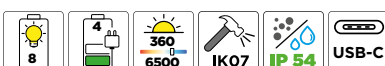

\*Recommended user price applicable from 01/09/2024 to 31/08/2025. Illustrations non contractual. Offer valid from 01/01 to 31/03/2025. In case of stock shortage, Clas reserves the right to deliver a gift of equivalent value.

## RECHARGEABLE RAMP 1200LUMENS

OE 0179

The light ramp is quick and easy to install, so you can work hands-free under the hood or in the passenger compartment.

**92** €VAT Excl.

Instead of 99 €VAT Excl.\*

**+** Two choices:  
Powerful lighting:  
1200Lumens  
Soft lighting:  
400Lumens



## MOBILE SPOTLIGHT COB 1000LUMENS

OE 0499

**32** €VAT Excl.

Instead of 34 €VAT Excl.\*

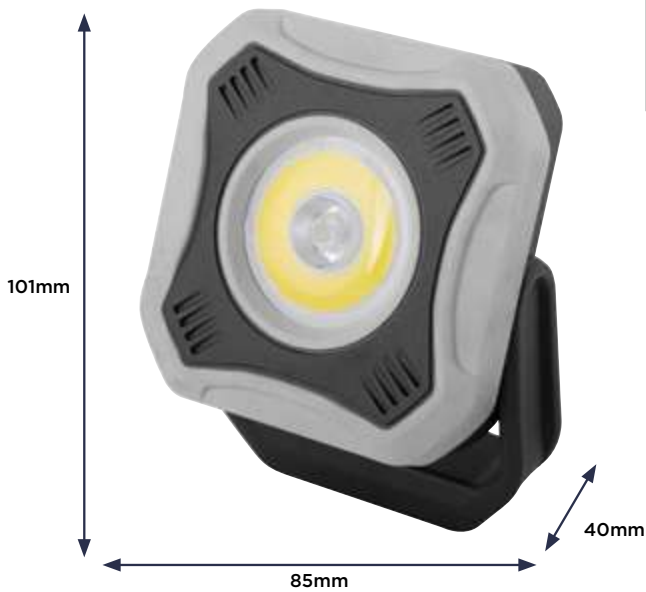

TN

## ELECTRIC ARC PROTECTION HELMET WITH RETRACTABLE FACE SHIELD

OE 0312

**205** €VAT Excl.  
Instead of 219 €VAT Excl.\*



Face protection against thermal effects and flash, consequences of electric arcs.

NO WARRANTY

TN

## MARKING/WORK AREA SIGNALING SET

EG 0012

**155** €VAT Excl.  
Instead of 179 €VAT Excl.\*



NO WARRANTY

TN

## E-MOBILITY ELECTRIC/HYBRID VEHICLE SET

OE 0377

This kit is dedicated to professionals working on specific jobs. Dedicated to tow trucks, wreckers/recyclers, technical control, firefighters.

**649** €VAT Excl.  
Instead of 699 €VAT Excl.\*



OE 0840



OE 0844



OE 0564



OE 0563



EG 0031



OE 0562



OE 0764



EG 3120

### Contents:

- OE0840: 1000V insulated tool set for hybrid and electric vehicles (27pcs)
- OE0764: 660mmx360mm self-gripping insulating mat
- OE0844 (x4): insulated fixing clamp
- OE0562: lockout bag
- OE0564: lockout padlock
- OE0563: locking disc
- EG0031: hazard steering wheel cover
- EG3120: wheeled case

## ELECTRIC/HYBRID VEHICLE UNDER VOLTAGE OPERATION SET

OE 0378

This kit is dedicated to professionals involved in live electrical work.  
Dedicated to consignment supervisors, body repairers/  
painters, diagnostic technicians, paint strippers/recyclers, etc.

1890 €VAT Excl.

Instead of 1999 €VAT Excl.\*



OE 0660



OE 0683



OE 0820



OE 0850



OE 0870



OE 0880

**Contents:**

- EG0076: 4-drawer trolley + 1 PL box
- OE0660: 1/4" insulated ratchet and socket inserts (46 pcs)
- OE0683: insulated flat wrench insert (15 pcs)
- OE0820: 3/8" insulated ratchet and socket inserts (14 pcs)
- OE0850: insulated 12-sided offset wrench inserts (11 pcs)
- OE0870: insulated pliers insert (4 pcs)
- OE0880: insulated screwdriver inserts (7 pcs)
- EG0080 (x2): foam storage box

## CHARGING CABLE T2-T2 22kW 5m

OE 2043

215 €VAT Excl.

Instead of 229 €VAT Excl.\*



**Specifications:**

- 22KW
- 32 A
- 3 phases
- length : 5m
- plug : type 2



22KW



**2 COLUMNS ASYMETRIC POST LIFT WITH BASEMENT 400V 4T 2ARMS 1.10+1.50m**

PE 2100T

**3999** €VAT Excl.

**LOW PASSAGE**

**+ FREE TRANSPORT COST**

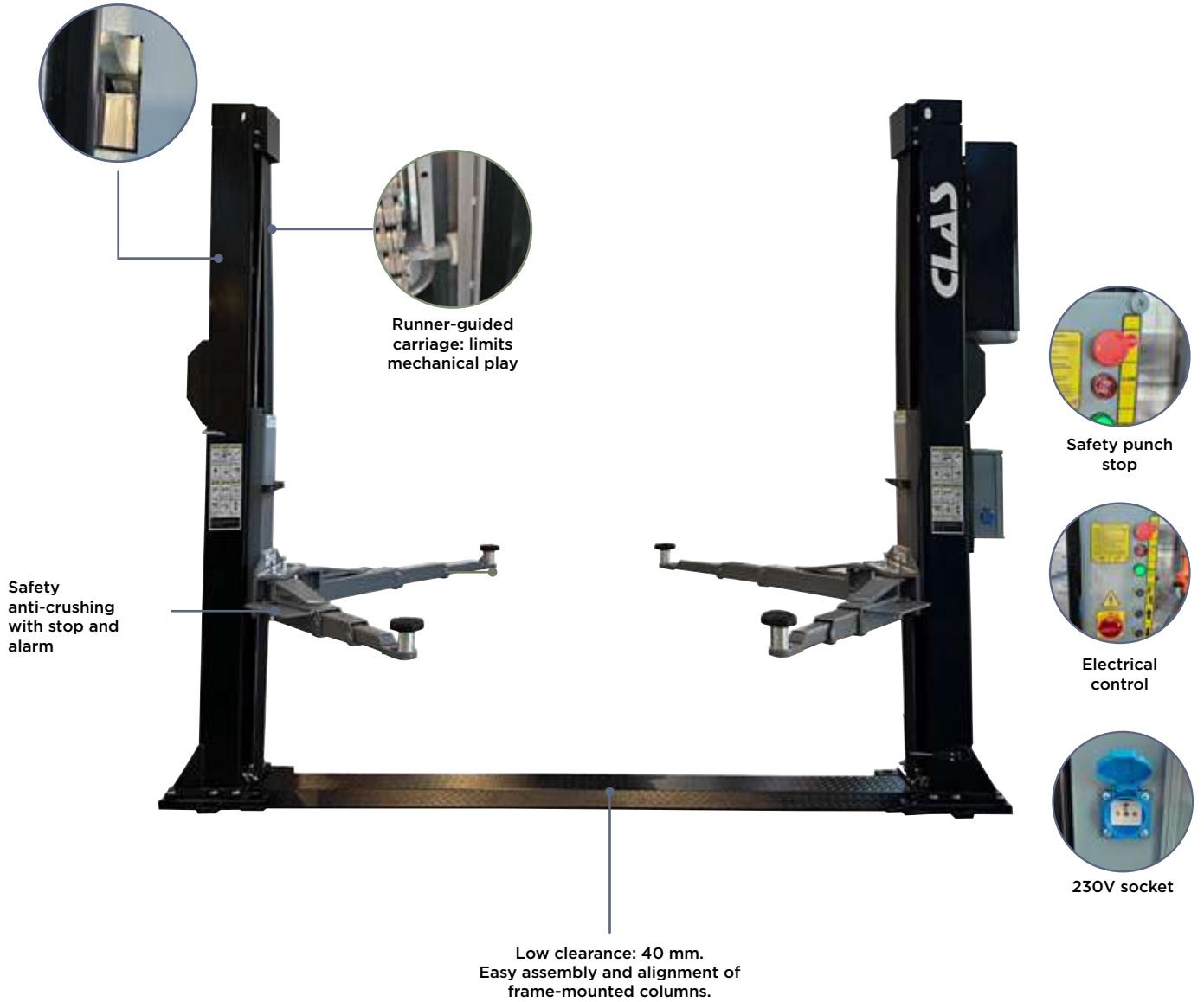

**Specifications:**

- lifting height: 100-2100mm
- lifting time: +/- 50s
- lowering time: +/- 30s
- drive power: 2.2kW
- drive voltage: 400V/50 V/Hz
- adjustable screw buffers, stroke 70-140mm
- automatic release of safety catches
- emergency lowering system in the event of power failure
- system synchronization: by cable
- intermediate stop 20 cm above ground for user safety and anti-crushing audible signal
- engine protection
- door protection on columns
- 230V electrical socket on electrical box
- protective strip for cylinder, chain and cables included on each column
- supplied with 4x70mm risers and brackets
- Epoxy paint

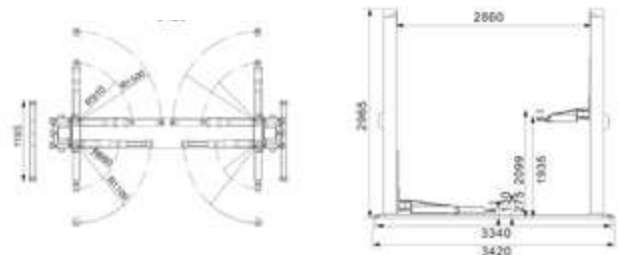

Max. T **4** ↑ 2100 ↓ 100 mm 400V **2200 W**

**4T** **2** WARRANTY

## MOBILE SCISSOR LIFT DUAL CYLINDER LOW RAISE 230V 3T

PE 6102M

Especially adapted to painting, bodywork and brake and tyre service activities.

Easy access: 115mm lowered floor clearance, lockable access ramps to extend platforms.

Working comfort: easy to move thanks to removable wheels and traction handle. Easy storage of components on the console.



Electric rack locking,  
no pneumatic power  
supply required



115mm  
Extra flat



3199 €VAT Excl.

**+**  
**FREE**  
**TRANSPORT COST**

3T

## DOUBLE SCISSOR LIFT 400V 3.6T LOW PROFILE ON/IN-GROUND

PE 6236T

Especially adapted to painting, bodywork and brake and tyre service activities.

Installation possibilities: in or on ground.

Easy access: 110mm lowered floor clearance, lockable access ramps to extend platforms.

Maximum comfort and safety: double hydraulic master-slave safety system, combined with a rack and pinion system, to maintain the lift in position for long periods.



Rack and pinion  
safety

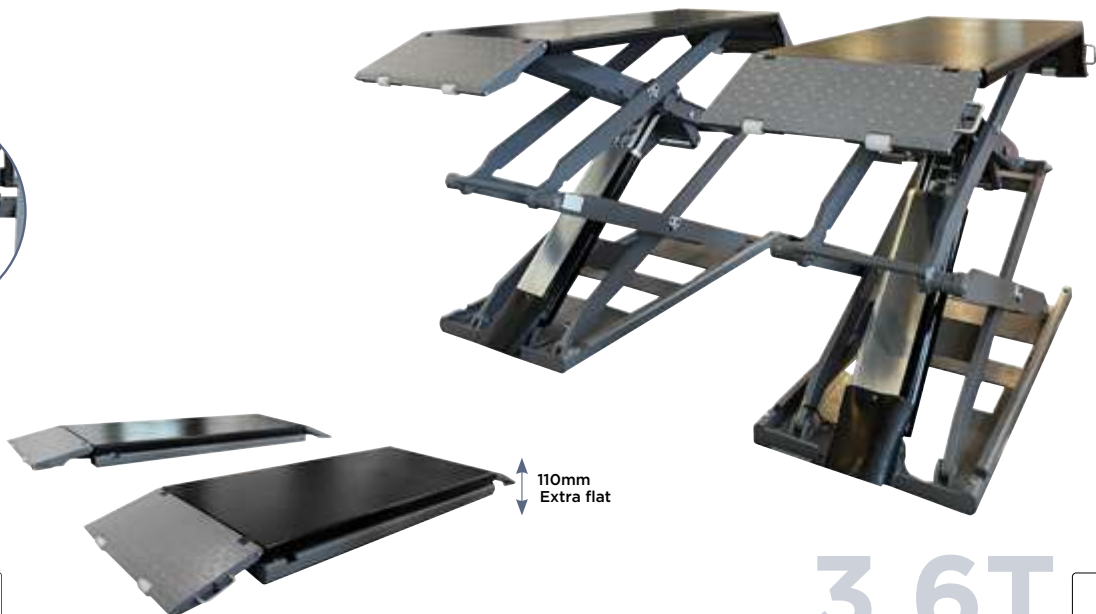

110mm  
Extra flat

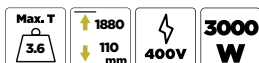

5799 €VAT Excl.

**+**  
**FREE**  
**TRANSPORT COST**

3.6T



TN

## EXTRA FLAT TROLLEY JACK 2T 85mm

OH 5304

79 €VAT Excl.

Instead of 99 €VAT Excl.\*

**Specifications:**

- rotating saddle
- safety overload system
- h. min.: 85mm
- h. max.: 381mm
- dimensions: 560x212x145mm
- weight: 13kg

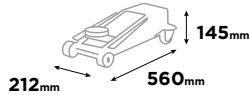

2T **2** WARRANTY

## EXTRA FLAT TROLLEY JACK 3T 75mm

OH 7014

279 €VAT Excl.

Instead of 299 €VAT Excl.\*



Double pump : rapid rise



Approach pedal



**Specifications:**

- foot pedal
- control lowering system
- safety overload system
- swiveling rubber saddle
- fast lifting dual pump system
- foam protection on handle
- PU front and rear wheels
- h. min: 75mm
- h. max: 510mm
- dimensions: 740x350x230mm
- weight: 32.5kg

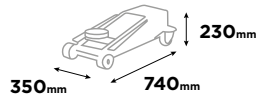

+ Extra low profile



3T **10** WARRANTY

## PAIR OF 2T JACK STANDS WITH SECURITY PIN

OM 3002BL

**BLINE**  
BUDGETSOLUTION

35 €VAT Excl.

Instead of 41 €VAT Excl.\*

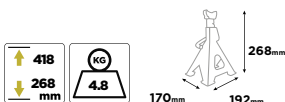

2T **2** WARRANTY

## PAIR OF 3T JACK STANDS WITH SECURITY PINS

OM 3030

49 €VAT Excl.

Instead of 52 €VAT Excl.\*

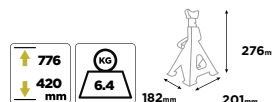

3T **2** WARRANTY

## DUAL-CONTROL HYDRAULIC PRESS 30T SLIDING CYLINDER

OH 0931

1890 €VAT Excl.

Instead of 1999 €VAT Excl.\*



+ Sliding jack and winch

### Specifications:

- hydraulic pump
- manual override or hydropneumatic pedal
- chrome piston with adjusting screw
- sliding cylinder jack with handle and rating scale
- polycarbonate protection to protect the operator from splinters
- table height adjustable 12 positions
- winch-assisted up and down movement of the table
- 2 oversized pins to hold the table in place
- 226x136x55mm sliding drip tray
- large manometer
- reversible V-shaped support block, including punch kit and protective polycarbonate

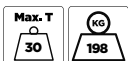

30T 

## UNIVERSAL 20-30T PRESS SUPPORT STRUCTURE

OH 0833

Ensures that the part under the press is stable and held in place. Allows the height to be adjusted and the part to be precisely positioned.



190 €VAT Excl.

Instead of 232 €VAT Excl.\*

 2 WARRANTY

## DRY AND WET VACUUM CLEANER 2x1000W

EG 0040

**399** €VAT Excl.

Instead of 429 €VAT Excl.\*



### Specifications:

- stainless steel tank mounted on a 4-wheel dolly
- 2 motors of 1000W each
- 80l tank Ø420mm
- drain on 500mm tank
- pressure: 21kPa
- air flow: 108l/s
- sound level: 73dB
- power supply 230V 4m cable
- power: 2000W
- dimension (lengthxdepthxheight): 540x595x940mm



## PARALLEL JAW CLAMPS 150mm QUICK TUBE HOSE APPROACH

OM 4066

Releasable jaw system allowing you to make adjustments to the jaw immediately.

**219** €VAT Excl.

Instead of 249 €VAT Excl.\*

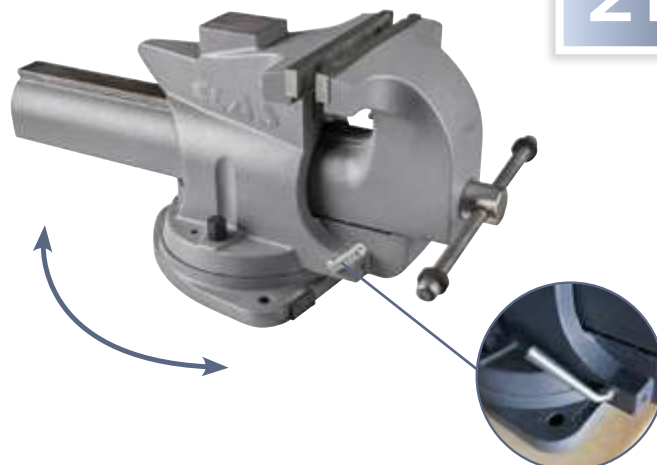

### Specifications:

- jaw width: 150mm
- jaw height: 20mm
- opening: 180mm
- interchangeable steel jaws
- supplied with revolving base with 3 anchoring points
- weight: 24kg



## 6 DRAWERS + 154 TOOL ROLLER CABINET

EG 6154

**790** €VAT Excl.  
Instead of 847 €VAT Excl.\*



OS 1200



OS 4100



OS 3000



OS 5000



OS 6000



OS 3200



## 7 PCS T-HANDLE WRENCH INSERT TORX T10-T40

OS 2100

**39** €VAT Excl.  
Instead of 49 €VAT Excl.\*



Format: 1/3 drawer  
Insert dimensions: 390x185x50mm  
PP+TPV ergonomic dual material handle



## 7 PCS TORX SCREWDRIVER INSERT T10-40

OS 1100

**35** €VAT Excl.  
Instead of 44 €VAT Excl.\*

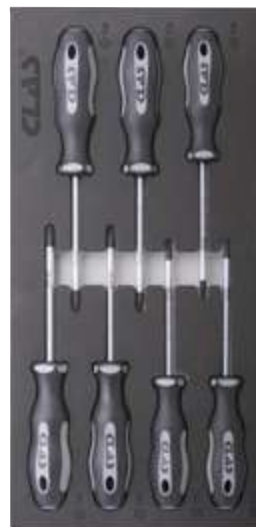

Format: 1/3 drawer  
Insert dimensions: 390x185x50mm  
PP+TPV ergonomic dual material handle  
DIN ISO 8764



## REPAIR BAG 4 INSERTS 103 TOOLS

EG 3111



OS 3000



OS 3200



OS 5000



OS 4100

299 €VAT Excl.

Instead of 319 €VAT Excl.\*

**Contents:**

- EG3110: tool bag with shoulder strap
- OS3000: 1/2" ratchet inserts (23pcs)
- OS3200: 1/4" ratchet inserts (59pcs)
- OS5000: pliers insert (4pcs)
- OS4100: 6-24mm combination wrench inserts (17pcs)

## REPAIR CASE 6 INSERTS 115 TOOLS

EG 3121



OS 3000



OS 3200



OS 5000



OS 4100



OS 5200



OS 1200

429 €VAT Excl.

Instead of 499 €VAT Excl.\*

**Contents:**

- EG3120: wheeled case
- OS3000: 1/2" ratchet insert (23pcs)
- OS3200: 1/4" ratchet insert (59pcs)
- OS5000: pliers insert (4pcs)
- OS4100: 6-24mm combination wrench inserts (17pcs)
- OS5200: circlip pliers insert 178mm inside-outside (4pcs)
- OS1200: PH-slot diamond screwdriver insert (8pcs)

## REPAIR BACKPACK 139 TOOLS

EG 3131



OS 3000



OS 3200



OS 5000



OS 4100

299 €VAT Excl.

Instead of 349 €VAT Excl.\*

**Contents:**

- EG3120: wheeled case
- OS3000: 1/2" ratchet insert (23pcs)
- OS3200: 1/4" ratchet insert (59pcs)
- OS5000: pliers insert (4pcs)
- OS4100: 6-24mm combination wrench inserts (17pcs)
- OS5200: circlip pliers insert 178mm inside-outside (4pcs)
- OS1200: PH-slot diamond screwdriver insert (8pcs)



OE 3008BL



TN

## SHOULDER TOOL BAG

EG 3110



**45** €VAT Excl.  
Instead of 49 €VAT Excl.\*

**Specifications:**

- length: 46cm
  - width: 25cm
  - height: 28cm
  - 15 pockets:
- 6 parallel inside 12 X 4cm + large storage space  
 9 outside, including 3 front Velcro pockets 12 x 12cm,  
 3 open pockets on back 14 x 14cm  
 1 right side pocket 14 x 22cm, 2 left side pockets 10 x 14cm

Lockable zip closure with padlock.



## WHEELED SUITCASE

EG 3120



**85** €VAT Excl.  
Instead of 99 €VAT Excl.\*

**Specifications:**

- length: 50cm
- width: 30cm
- height of retractable handle, folded: 40cm
- unfolded retractable handle height: 100cm

19 pockets:  
 8 inside, including 1 with Velcro along the length, 1 in aerosol format, 6 in identical format 6 x 12cm, large main storage compartment  
 11 outside, including 1 with scratch on front 20 x 20cm, and 4 in 10 x 12cm format  
 3 + 3 lateral (1 8 x 18cm 2 6 x 18cm)



## BACKPACK

EG 3130



**75** €VAT Excl.  
Instead of 89 €VAT Excl.\*

**Specifications:**

- height: 50cm
- length: 35cm
- width: 25cm
- external storage: 4 zipped pockets + 1 single pocket + storage slots
- interior storage: 18 pockets + 40 storage slots- height: 50cm- length: 35cm- width: 25cm- external storage: 4 zipped pockets + 1 single pocket + storage slots- interior storage: 18 pockets + 40 storage slots



Tools not included



TN

**1/2" IMPACT WRENCH 620Nm 20V  
BRUSHLESS + 2 BATTERIES 4Ah + CHARGER**

PW 0620

Compatible with Makita batteries  
Auto stop" mode on loosening: when  
the bolt is sufficiently loosened, the tool  
automatically stops in less than a second.  
Supplied in suitcase



AUTO STOP  
MODE



1/2"

**299** €VAT Excl.

Instead of 319 €VAT Excl.\*

**620Nm**

TN

**1/2" IMPACT WRENCH 1080Nm 20V  
BRUSHLESS + 2 BATTERIES 4Ah + CHARGER**

PW 1080

Compatible with Makita battery  
«Auto stop" mode on loosening: trigger fully  
depressed, when the bolt is sufficiently loosened  
the tool automatically stops in less than a second.  
Supplied in suitcase

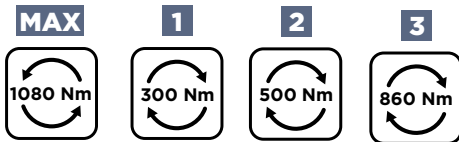

AUTO STOP  
MODE



1/2"

**419** €VAT Excl.

Instead of 449 €VAT Excl.\*

**1080Nm**

TN

**20V BRUSHLESS HAMMER DRILL  
+ 2 BAT 4Ah + CHARGER**

PW 2013

Compatible with Makita batteries  
Supplied in suitcase

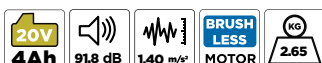
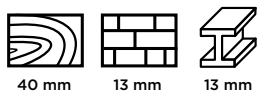

**349** €VAT Excl.

Instead of 379 €VAT Excl.\*

**160Nm**

\*Recommended user price applicable from 01/09/2024 to 31/08/2025. Illustrations non contractual. Offer valid from 01/01 to 31/03/2025. In case of stock shortage, Clas reserves the right to deliver a gift of equivalent value.

TN

## ANGLE GRINDER 125mm 20V BRUSHLESS + 2 BATTERIES 4Ah + CHARGER

PW 3125

125mm

249 €VAT Excl.

Instead of 269 €VAT Excl.\*

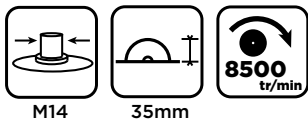

Supplied in transportable case with 2 x 4.0Ah batteries and 2.3A charger

50 cuts autonomy (Ø10mm steel bar)\*  
\*[indicative value].

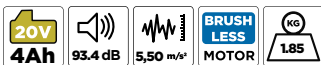

## 1/2" D. IMPACT WRENCH 1600Nm DOUBLE HAMMER

OP 1522BL

TN

69 €VAT Excl.

Instead of 75 €VAT Excl.\*

### Specifications:

- dual hammer technology
- loosening torque: 1600Nm
- tightening torque: 850Nm
- speed: 8,500 rpm
- connection: 1/4"
- recommended hose Ø: 10mm
- supply pressure: 6.2bar
- consumption: 170l/min
- length: 185mm
- net weight: 2.1kg
- supplied with connector



1600Nm



## 1/2" D. COMPACT IMPACT WRENCH 1200Nm

OP 1523

TN

149 €VAT Excl.

Instead of 169 €VAT Excl.\*

### Specifications:

- dual hammer technology
- loosening torque: 1200Nm
- tightening torque: 550Nm
- speed: 12,000 rpm
- connection: 1/4"
- recommended hose Ø: 10mm
- supply pressure: 6.2bar
- consumption: 170l/min
- length: 125mm
- net weight: 1.25kg



1200Nm





TN

## IMPACT SOCKET 1/2" KIT FOR ALU RIMS (4 PCS)

OM 7036

Set including the essential sleeves for the dismantling of aluminum rims equipped with specific impression studs.

Length: 85mm

### Contents:

- 15mm ultra thin specific socket SMART
- OM7016: 17mm specific socket MERCEDES/MAYBACH
- OM7026: 21mm specific socket HYUNDAI/KIA
- SA5021: 22mm specific socket OPEL



29 €VAT Excl.

Instead of 42 €VAT Excl.\*



## IMPACT TWISTED SOCKET SET FOR DAMAGED NUTS Ø6-27mm (15 PCS)

OM 8073

These boxes allow you to extract damaged bolts and remove the wheel anti-theft system when the removal sleeve is lost. The sleeve's helical shape provides the necessary grip for loosening.



175 €VAT Excl.

Instead of 192 €VAT Excl.\*

## WHEEL MOUNTING GUIDE SET M12-M14

OM 9320

**+** Prevents wheel falls, prevents MSD

59 €VAT Excl.

Instead of 69 €VAT Excl.\*



Insert without screwing  
Equipped with a plastic ring, they do not damage the threads in the hubs.  
For wheels with M12 and M14 bolts.



## TORQUE WRENCH

High precision torque wrench in Newton meter, graduated in decimal with precision of 1 in 1.  
 The wrench also works for reverse pitch torque.  
 The audible click is easily recognizable when the set value is reached.  
 The spring-loaded setting ring automatically locks in the desired torque value.  
 No risk of losing the value during use.  
 The 72-tooth reversible ratchet allows for a short adjustment, with push-button locking of the sockets.



72-tooth ratchet

Automatic locking



**+** Delivered with calibration certificate

REF	Square	Tightening torque	Length	Weight	Reading	Price
OM 0795	3/8"	10-60 Nm	295 mm	410 g	0.5 -> 0.5	69 <sup>€VAT Excl.</sup> instead of 89 <sup>€VAT Excl.*</sup>
OM 0792	1/2"	40-220 Nm	525 mm	1150 g	1 -> 1	79 <sup>€VAT Excl.</sup> instead of 99 <sup>€VAT Excl.*</sup>



## MEASURING TOOLS INSERT (6PCS)

AC 0000

**119** €VAT Excl.

Instead of 129 €VAT Excl.\*

### Specifications:

- Format: 1/3 drawer
- ruler: 150mm
- scribing tip: 146mm
- depth gauge: 200mm
- square: L.100Xl.70mm
- caliper: 150mm
- micrometer 0-25mm



TE

## THINKCAR T-WAND 100 DIAGNOSTIC TOOL

AD000TKTT1

**299** €VAT Excl.  
Instead of 320 €VAT Excl.\*



Product available for sale only  
in France



TN

## 4 TIRE DEFLATOR SET FOR TPMS VALVES

OM 7090

**11** €VAT Excl.  
Instead of 20 €VAT Excl.\*

4 plugs indicated: LF (AVG)-RF  
(AVD)-LR (ARG)-RR (ARD).  
Permitting:  
-Controlled air release (no valve  
deterioration)  
-Disassembly aid notes to help with  
reassembly.  
This will avoid reprogramming and  
using the diagnostic tool.



TN

## TPMS TOOL SET

OM 7096

**129** €VAT Excl.  
Instead of 195 €VAT Excl.\*

### Contents:

- 2pcs 1/4" D. adjustable torque drivers: 0.4-2Nm, 2-10Nm
- 2pcs deep sockets 11 and 12mm
- 1pc 1/4" D. T-handle
- 1pc 1/4" D. 100mm extension bar
- 2pcs 1/4" D. Torx bit socket : T10, T20
- 1pc 1/4" D. valve core tool
- 1pc composite TPMS grommet tool L.190mm



TN

## DEPTH GAUGE FOR TIRES

AC 4951

**18** €VAT Excl.  
Instead of 21 €VAT Excl.\*



**+** Calibration  
certificate



TN

## EURODAINU INFLATOR GUN 0.7-11BAR

OP 0149

**89** €VAT Excl.  
Instead of 99 €VAT Excl.\*



## ELECTRIC BRAKE AND CLUTCH BLEEDER 5L 2.5bar

HU 1101

Compact and lightweight.  
Automatic stop when the level in the can is too low.  
Automatic bleeding after canister change.  
Checks the low pressure brake system for leaks.

**+** Maintaining liquid thrust under continuous pressure, pulsating flow

### Specifications:

- 230V power supply (5m cord)
- equipped with an on/off switch
- equipped with a pressure regulator 0-2.5bar with maintenance of the thrust of the liquid in pulsating flow
- pressure gauge for pressure control
- suitable for clutches and brakes (compatible with ABS, EDS, ESP, SBC systems)
- 5 litre capacity allowing several operations
- interchangeable canister: ensures compatibility of the DOT3/DOT4/DOT5/DOT6 liquid
- flexible L.3.5m
- dimensions: 460x300x320mm
- weight: 10kg



Supplied with metal plug Ø43mm



+

**OFFERED**

UNIVERSAL BRAKE BLEEDER CAP

HU 1222

48 €VAT Excl.



## PNEUMATIC BRAKE CALIPER REWIND SET (22PCS)

OP 4506

**159€VAT Excl.**

Instead of 179 €VAT Excl.\*



### Specifications:

- Gun weight: 1.07 kg
- Size : 258x173x97mm
- Working pressure: 7b
- Noise emission: 64.3 dB
- Vibration emission: 0.876 m/s<sup>2</sup>



## BRAKE CALIPER RIGID SPRING PULLER

OM 2121

**49€VAT Excl.**

Instead of 59 €VAT Excl.\*

This tool is specially designed to remove and reinstall rigid brake springs smoothly and in security.



TN

## CO2 DETECTION KIT

AC 3300



Yellow liquid = cylinder head gasket out of order

- checks for gas combustion in the radiator
- the test fluid changes colour if a leak is detected
- fast identification of defective head gasket



**125** €VAT Excl.  
Instead of 146 €VAT Excl.\*

TN

## WATER PUMP FLOW TESTER

AC 1007



### Specifications:

- manometer
- hose L.200cm
- stepped male adapter for hoses Ø8mm to 20mm
- conical female adapter for rigid pipes Ø7 to 22mm
- 3 rubbers for female adapter
- 2 caps



**89** €VAT Excl.  
Instead of 137 €VAT Excl.\*

TN

## CLAMP PLIERS SET (9PCS)

OM 9358

**59** €VAT Excl.  
Instead of 69 €VAT Excl.\*



TN

## DISMOUNTING LEVER FOR SELF-TIGHTENING CLAMPS L.215mm

OM 5039

**15** €VAT Excl.  
Instead of 17 €VAT Excl.\*



TN

## TIE-ROD ASSEMBLER/REMOVER Ø30-Ø45mm WITH INTERCHANGEABLE HEADS 4PCS

OM 9175

149 €VAT Excl.

Instead of 179 €VAT Excl.\*

### Specifications:

- Ø head 30-35mm: 72mm
- Ø head 35-40mm: 78mm
- head Ø40-45mm: 90mm
- the head is retained in place using screws for greater security
- 1/2" drive + 32mm hexagonal for greater force
- length including head: 410mm (Hollow)
- weight: 2kg



NO WARRANTY

## SPRING COMPRESSOR 2300Kg

OM 2300

299 €VAT Excl.

Instead of 349 €VAT Excl.\*

**+** Universal Safety: spring lock



2 WARRANTY

## BALL JOINT ASSEMBLY/DISASSEMBLY SET

OM 2521

79 €VAT Excl.

Instead of 85 €VAT Excl.\*

Especially designed to remove suspension ball joints.



2 WARRANTY

## REINFORCED PNEUMATIC SPRING COMPRESSOR (2.4T) WITH ARTICULATED JAWS

OP 3221

2699 €VAT Excl.

Instead of 2799 €VAT Excl.\*

**+** Conformity 2006/42CE

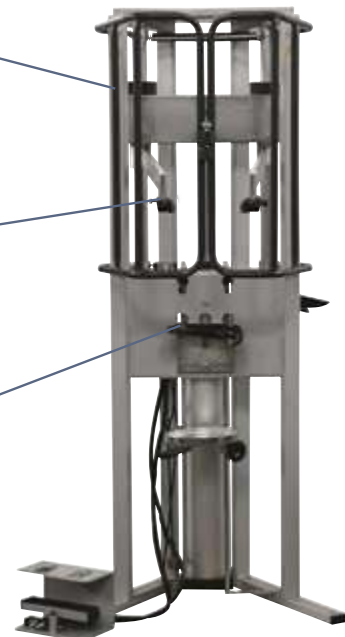

### Specifications:

- height: 1600mm
- base: length: 847mm width: 628mm
- working pressure 6bar/max 10bar
- compression strength 2452kg
- use and maintenance instruction book.
- color: grey
- 2 position adjustable lower cup (e.g. Chrysler, Dodge RAM long travel shock absorber...)
- weight: 70kg

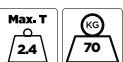

2.4T

5 WARRANTY

## SILENT-BLOCK & BEARING ASSEMBLY/DISASSEMBLY SET

OM 9391BL

**B.LINE**  
BUDGET SOLUTION

**165** €VAT Excl.

Instead of 179 €VAT Excl.\*



### Contents:

- 4 threaded rods with nuts mounted on bearings: M10-M12-M14-M14
- 2 support rings
- socket sets:  
46x36, 58x48, 70x60, 82x72, 80x70, 68x58,  
56x36, 44x34  
74x64, 62x52, 50x40, 60x50, 48x38, 72x62  
78x68, 66x56, 54x44, 76x66, 64x54, 52x42



## MECHANICAL & HYDRAULIC CV JOINT PUSHER 10T

OH 0569

Multi-solution case for cardan joint, ideal for the extraction of an element linked to the undercarriage and the braking system.

**245** €VAT Excl.

Instead of 269 €VAT Excl.\*



## CARDAN SHAFT EXTRACTOR

OM 3511

To be used with slide hammer.

**17** €VAT Excl.

Instead of 30 €VAT Excl.\*



Threading M18x150



TN

## RING PLIERS+4 SHELLS

OM 8024

Locking pliers supplied with 4 sets of interchangeable clamps for tightening the snap ring on the transmission shaft to reinstall the seal (bowl) on the transmission when using the SNR OBK (Outer Boot Kit) and OJK (Outer Joint Kit) types

**+** Safe operation, no risk of rush damages

**190** €VAT Excl.

Instead of 229 €VAT Excl.\*



Suited for splines:  
 Ø23,8mm 29 teeth  
 Ø24,6mm 30 teeth  
 Ø26,97mm 33 teeth  
 Ø28,57mm 35 teeth

These shells cover about 80% of the park.



TN

## CV JOINT GAITER EXPANDER 25-115mm

OP 0630

**165** €VAT Excl.

Instead of 189 €VAT Excl.\*



**Specifications:**

- capacity: 25 to 115mm
- power: pneumatic 1/4"
- weight: 2.1kg



TN

## CUTTING PLIERS FOR CARDAN BELLOWS

OM 8026

**13** €VAT Excl.

Instead of 19 €VAT Excl.\*





## GENERATION 1+2 RENAULT/PSA TIMING TOOL ROLLER CABINET

OM 9594

1650 €VAT Excl.

Instead of 1750 €VAT Excl.\*



OM 6100



OM 6110



Motor code, OEM code  
Find the products associated with your **engine code** or **OEM code** by entering them in the search bar on **clas.com**.



OM 6200



OM 6210



Composition:  
OM6110 : 1 x complete renauld generation 2© timing set.  
OM6210 : 1 x complete psa generation 2 timing set  
OM6100 : 1 x complete distribution renauld/nissan/opel/volvo generation 1  
OM6200 : 1 x psa generation 1 complete distribution set  
EG0098 : 1 x 8-drawer cabinet



## MULTI-BRAND TIMING TOOL TROLLEY GENERATION 1 + RNLT/PSA GENERATION 2

OM 9901

2890 €VAT Excl.

Instead of 3050 €VAT Excl.\*



OM 6100



OM 6110



OM 6200



OM 6210



OM 6300



OM 6400



Composition:  
OM6100: 1 x complete renauld/nissan/opel/volvo generation 1 timing set  
OM6200: 1 x psa generation 1 complete timing set  
OM6300: 1 x complete timing set vag  
OM6400 : 1 x complete timing set fiat/alfa/lancia/opel/suzuki/ford  
OM6500 : 1 x complete timing set opel/chevrolet/saab/fiat/lancia/suzuki/ford  
OM6600: 1 x ford/volvo complete timing set  
OM6110 : 1 x complete timing set renauld generation 2©  
OM6210 : 1 x psa generation 2© complete timing set  
EG0098 : 1 x 8-drawer workbench



OM 6500



OM 6600



TN

## SEAL TOOL KIT 24PCS

OM 5038

This kit allows the SPI seals to be replaced with diameters of Ø21.5 to Ø64mm.  
Removal: compact puller with unique extracting hooks, quick removal without any damaging.  
Installation: the interchangeable seal mandrels mean that the seal can be guided back into place for perfect positioning.  
2 pairs of claws L.70 and L.115mm for increased polyvalence.

109 €VAT Excl.

Instead of 174 €VAT Excl.\*



## PSA/FORD AUXILIARY BELT TENSIONER SET

OM 3694



99 €VAT Excl.

Instead of 119 €VAT Excl.\*



### Applications:

Citroën: C1, C2, C3 III, C3 Pluriel, C4 Picasso  
Ford: B-Max, C-Max, Fiesta, Focus, Focus C-Max, Fusion, Galaxy, Grand C-Max, Mondeo, S-Max, Tourneo, Transit.  
Mazda: 2, 3  
Mini: One, Cooper, Clubman  
Peugeot: 107, 1007, 206, 206 CC, 206 SW, 307, 307 SW, 508  
Toyota: Aygo  
Volvo: C30, S40, S80, V50, V70

**Engines:** 1.4, 1.4 TDCI, 1.4 DiD, 1.5 TDCI, 1.6 HDI, 1.6 TDCI, 1.6 16v, 1.6 D4, 2.0 HDI, 2.2 HDI



## GLOW PLUG ANALYZER

AC 5300



69 €VAT Excl.

Instead of 95 €VAT Excl.\*



### Specifications:

- beep alarm to help the user to analyze the glow plug status
- built-in LED light enables the user to work in the darkness
- a backlit LCD makes the analyzer easy to read in all lighting conditions
- auto switch-off helps to conserve battery life if the user forgets to turn it off



11V 10V 8,5V 7V 5V 4,4V



## VIBRATION GLOW PLUG REMOVAL KIT 1/4"

OP 1404

Allows the glow plugs to be removed in a progressive, controlled and secure manner.  
Reduces the risk that the electrode may break within the glow plug's housing.



175 €VAT Excl.

Instead of 199 €VAT Excl.\*



### Contents:

- SA1404: vibration socket 1/4"
- SA1408: vibration socket 8mm
- SA1409: vibration socket 9mm
- SA1410: vibration socket 10mm
- SA1411: vibration socket 11mm
- SA1412: vibration socket 12mm
- SA1413: vibration extension 50mm
- SA1414: vibration extension 100mm
- SA1415: 1/4" universal joint for vibration socket

4 torque settings: 10-20-30 or 40Nm  
Drive: 1/4"



## SPARK PLUG COMPLETE INSERT (15PCS)

OM 0415

The perfect complete kit for all your spark plug work.

Contents :

- specific VAG tools (4pcs)
- long spark plug socket 3/8" 12pans, L.250mm 14-16-21mm (3pcs)
- short spark plug socket 3/8" 12pans, L.65mm 14-16-18-21mm (4pcs)
- universal socket 3/8" 12pans 14mm
- torque limiter 3/8" 18Nm-24Nm (2pcs)
- adapter 3/8" F x 3/8" M



2/3 drawer format for CLAS servants



195 €VAT Excl.

Instead of 219 €VAT Excl.\*



## DAMAGED GLOW PLUG EXTRACTION SET M8-M10

OM 3778

Lets you remove deteriorated or broken glow plugs.  
For tapping glow plugs M8-M10 (VW-Audi, Mercedes, Opel, Peugeot, Renault etc.)



290 €VAT Excl.

Instead of 325 €VAT Excl.\*



## M8-M9-M10 GLOW PLUG ELECTRODE EXTRACTION KIT

OM 3790

Kit to extract the final part of the electrode which is impossible to pull out if it splits or seizes inside the M8, M9 or M10 glow plug seat.  
This easy-to-use kit considerably reduces labor hours and cost of labor.  
It is also compatible with specific engines equipped with M8 glow plugs with electrodes of the diameter of M10 glow plugs (see specific applications to find the vehicles concerned).



395 €VAT Excl.

Instead of 429 €VAT Excl.\*



## PETROL COMPRESSION GAUGE WITH RECORDER

AC 0100

- High precision easy-to-read large-scale 5-17bar diagram
- Fast connection with no tools required

**+** Recommended by manufacturers

**425** €VAT Excl.

Instead of 469 €VAT Excl.\*



**Supplied with:**

- 3 adaptors : M10-M12-M18
- 50 diagrams AC0110
- 6 expandable seals SA 0100
- Option to record 8 attempts (+ 2 in reserve)



## COMPRESSION MEASURING KIT FOR DIESEL ENGINES

AC 0224

Easy and ready to use, this kit covers 90% of vehicles. Applications available on request.

**+** Easy to use

**690** €VAT Excl.

Instead of 769 €VAT Excl.\*



## SMOKE LEAK DETECTOR

AC 0410

990 €VAT Excl.

Instead of 1375 €VAT Excl.\*

Low-pressure management protects components.  
Product quality for regular/intensive use.

### Specifications:

- power supply: 12V
- output pressure: 1.2 bar for turbo system / 0.05 bar for exhaust system
- flow rate: 8L/min
- smoke control
- mode of operation: air only or smoke
- control manometer
- oil capacity: 50ml
- mineral oil (included)
- supplied with its accessories
- test fluid 250 ml = 35 hours of use
- weight: 6Kg
- dimensions: 260x210x230mm



### Contents:

- main unit
- accessory case
- adapter cone
- power cable
- smoke distribution pipe
- funnel
- universal adjustable intake bag
- bag replacement rubber
- test fluid (250 ml)
- oil filler cap adapter (for most BMW vehicles)
- smoke diffuser
- EVAP system accessory kit (fuel vapour recovery system)
- set of blanking plugs



## STANDARD HEADLIGHT ADJUSTMENT DEVICE

AC 2005BL

**B.LINE**  
BUDGET SOLUTION

**779** €VAT Excl.

Instead of 820 €VAT Excl.\*

### Functions:

- control and measurement of the closing mechanism 0-4%
- control of the lateral adjustment  $\pm 5\text{cm}/10\text{m}$
- measurement of the illumination intensity 0-150klux/1m, 0-240lux/25m
- intervention on headlights (xenon, halogen, LED...), anti-fog

### Specifications:

- mirror type aligner
- digital luxmeter
- alu column (collapsible) graduated from 20 to 150cm
- sliding regulating mechanism
- metal housing with tilt adjustment
- power supply: 9V battery (supplied)
- dimensions: L.712xW.580xH.1810mm



## DUAL LASER HEADLIGHT ADJUSTMENT DEVICE

AC 2013

**949** €VAT Excl.

Instead of 999 €VAT Excl.\*

### Specifications:

- laser-type aligner (SA2037) compliant with standard EN 60825
- digital luxmeter
- alu column (collapsible) graduated from 20 to 150cm
- sliding regulating mechanism
- thermoplastic housing with tilt adjustment
- laser aligner power supply: 3 1.5V batteries (supplied)
- dimensions: L.712xW.580xH.1810mm
- UTAC NFR 63801 standard



TN

## 2-HANDLE LINE CUTTER KIT

OC 1500

A set of 2 handles allows to pull the inserted wire in the joint with the help of a needle.



**Contents:**

- OC4500: hollow leader needle
- OC2100: braided wire reel 0.8mmx0.8mmx44m
- OC2900: pair of grip pull handles



69 €VAT Excl.

Instead of 81 €VAT Excl.\*

## PAIR OF SUCTION CUPS Ø120mm

OC 0600

**Specifications:**

- swappable suction cups to suit various glass shapes
- lever lock
- carrying handle
- capacity: 120kg
- suction cups Ø120mm
- supplied with fast-ratchet sling
- sling length: 5m



115 €VAT Excl.

Instead of 134 €VAT Excl.\*

## DOUBLE SUCTION CUP

OC 0608



Suction strength 60kg  
 Ø160mm large suction cup  
 Ø90mm small suction cup



29 €VAT Excl.

Instead of 37 €VAT Excl.\*



## WINDSCREEN REPAIR KIT

OC 2203

429 €VAT Excl.

Instead of 449 €VAT Excl.\*

+ Easy to use



### Contents:

- SA4104: Battery-powered 12V UV lamp
- OC2202: Repair resin 10ml, yellow cap
- OC8064: Finishing resin 10ml, blue cap
- SA4108: 1 polish
- SA4109: 1 suction cup gel
- SA4105: 1 box of UV sheets
- SA4107: 1 inspection glass
- 1 scratching pencil
- SA4106: 1 injector holder
- OC2205x2: injectors
- 1 box of 10 blades
- 1 user's manual



2 WARRANTY

## SCRAPER AND UTILITY KNIFE SET

OC 0302

23 €VAT Excl.

Instead of 34 €VAT Excl.\*



### Contents:

- 1 cutter
- 5 straight blades 12mm (OC5301)
- 5 straight blades 16mm (OC5302)
- 5 straight blades 20mm (OC5303)
- 5 bevelled blades 16mm (OC5304)
- 5 trapezoidal blades (OC5305)

NO WARRANTY

# Selection WINTER

TN

## BODYWORK 3 TRAY STORAGE TROLLEY

OC 0711

Allows parts which have been uninstalled to be put away and stored such as headlights, headrests, instrument panels, bumpers...

### Specifications:

- 3 trays (2 wooden and 1 mesh)
- platform height: 260-810-1390mm
- mesh base
- 4 swiveling wheels, 2 of which have brakes
- dimensions: L.630xW.1110xH.1625mm



269 €VAT Excl.

Instead of 299 €VAT Excl.\*



TN

## BUMPER WALL BRACKET

OC 0727

### Specifications:

- length: 1000mm
- width: 500mm
- height: 1500mm



89 €VAT Excl.

Instead of 99 €VAT Excl.\*



TN

## MULTI-POSITION SUPPORT SHOCK ABSORBER

OC 0729

### Specifications:

- length: 1940-2040mm
- width: 300-600mm
- height: 1300mm



269 €VAT Excl.

Instead of 299 €VAT Excl.\*



## ROTATING PAINT RACK 2 RIMS

OC 0728

360° rotating easel for painting wheel rims.  
Adjustable in width and height from 1100 to 1420mm.  
For rims from 15" to 22".



**Specifications:**

- length: 1360mm
- width: 600mm
- height: 980-1260mm



**179** €VAT Excl.  
Instead of 199 €VAT Excl.\*

## CORDLESS THERMAL STAPLER + 300 STAPLES KIT

OC 6070



4-way adjustable head



Protection against overheating



Max. temperature **600°C**

**3.7V 4000mAh** 4000mAh Li-ion battery

**Specifications:**

- length (without electrode): 220mm
- total length: 255 mm
- width: 35mm
- heating temperature: 600°C
- input current: DC 5V 2A
- output current: 3.7 8A Max
- battery: 3.7V 4000mAh Li-ion
- charging time: 3H
- capacity 400 staples with battery in one charge (hot stapler)



CO 6072	BOX OF 50 STAPLES M Ø 0.6 MM	7€VAT Excl. instead of 9 €VAT Excl.*
CO 6073	BOX OF 50 STAPLES V Ø 0.8 MM	7€VAT Excl. instead of 9 €VAT Excl.*
CO 6074	BOX OF 50 STAPLES S Ø 0.6 MM	7€VAT Excl. instead of 9 €VAT Excl.*
CO 6075	BOX OF 50 STAPLES S Ø 0.8 MM	7€VAT Excl. instead of 9 €VAT Excl.*
CO 6076	BOX OF 50 STAPLES U Ø 0.6 MM	7€VAT Excl. instead of 9 €VAT Excl.*
CO 6077	BOX OF 50 STAPLES U Ø 0.8 MM	7€VAT Excl. instead of 9 €VAT Excl.*



## 4T COLLISION REPAIR SET

OC 0803

199 €VAT Excl.

Instead of 245 €VAT Excl.\*

**Contents:**

- SA0805: 4T hydraulic ram
- SA0806: 4T 1/4" hydraulic hand pump
- SA0804: spreader 500kg
- SA0802: hose 1/4"
- bit/support set
- SA1805: bodywork hydraulic ram 4T extension set



**Specifications:**

- minimum pusher cylinder travel: 325mm
- maximum pusher cylinder travel: 425mm



4T **2** WARRANTY

## 10T COLLISION REPAIR SET

OC 0804

+ High power

345 €VAT Excl.

Instead of 379 €VAT Excl.\*

A must-have tool for automotive and industrial repair work on straightening, handling and lifting.



**Contents:**

- SA0807: 10T hydraulic ram
- SA0808: 10T 1/4" hydraulic hand pump
- SA0804: spreader 500kg
- SA0802: hose 1/4"
- bit/support set
- SA1815: bodywork hydraulic ram 10T extension set

For SA 1815 :

Delivered with a set of 5 sleeved extensions :

- usable length: 546mm (with 590mm nozzle, Ø 30mm sleeve) (x1)
- usable length: 300mm (with 342mm nozzle, Ø 30mm sleeve) (x2)
- usable length: 197mm (with 234mm nozzle, Ø 30mm sleeve) (x1)
- usable length: 97mm (with nozzle 140mm, Ø 30mm sleeve) (x1)



10T **2** WARRANTY

## LOCK GRIP PLIERS SET (16 PCS)

OM 8069

129 €VAT Excl.

Instead of 155 €VAT Excl.\*

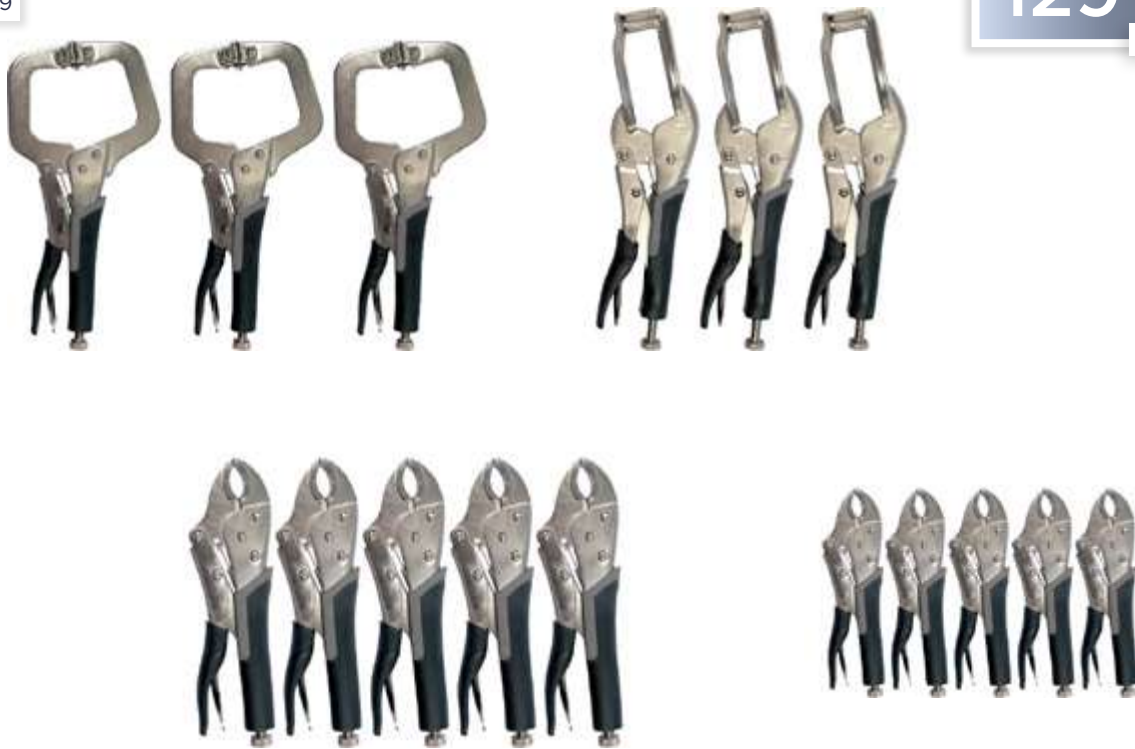

**Contents:**

- OM8082 (x3): lock grip pliers 285mm
- OM8080 (x5): lock grip pliers 225mm
- OM8083 (x3): lock grip pliers 240mm
- OM8081 (x5): lock grip pliers 190mm



## HAMMER + BLOCK SET (7 PCS)

OC 0811

+ Hickory handle

129 €VAT Excl.

Instead of 169 €VAT Excl.\*

Essential for all dent removal, straightening and sheet metal work.



**Contents:**

- 3 hammers with GENUINE HICKORY handles L.310mm:
  - OC0812: planishing hammer with round flat head and pointed tip
  - OC0813: planishing hammer with round flat head straight tip
  - OC0814: cornering hammer with round and square gridded head
- 4 blocks:
  - OC0815: comma 130x27mm
  - OC0816: rail/universal 60x60x56mm
  - OC0817: claw 78x60x27mm
  - OC0818: anvil 80x62x55mm



TN

## REAR PARKING SENSOR PUNCH MASTER TOOL KIT FORD (23 PCS)

OC 9100

1090 €VAT Excl.

Instead of 1250 €VAT Excl.\*

### Contents:

- OC 9101 rear parking sensor punch tool kit FORD #01 (4 PCS)
- OC 9102 rear parking sensor punch tool kit FORD #02 (4 PCS)
- OC 9103 rear parking sensor punch tool kit FORD #04 (4 PCS)
- OC 9104 rear parking sensor punch tool kit FORD #05 (4 PCS)
- OC 9105 rear parking sensor punch tool kit FORD #08 (4 PCS)
- OC 9106 rear parking sensor punch tool kit FORD #09 (4 PCS)
- OC 9107 rear parking sensor punch tool kit FORD #10 (4 PCS)
- OC 9108 rear parking sensor punch tool kit FORD #11 (4 PCS)
- OC 9109 rear parking sensor punch tool kit FORD #12 (4 PCS)
- OC 9110 rear parking sensor punch tool kit FORD #15 (4 PCS)



TN

## REAR PARKING SENSOR PUNCH MASTER TOOL KIT BMW (41 PCS)

OC 9138

890 €VAT Excl.

Instead of 990 €VAT Excl.\*

### Contents:

- punching device/centering pin Ø18.0mm for BMW/Skoda
- punching device/centering pin Ø18.2mm for VW/Seat
- punching device/centering pin Ø17.8mm for VW/Seat
- punching device/centering pin Ø18.4mm for VW
- punching device/centering pin Ø 19mm for FCA
- punching device/centering pin Ø24.0mm for Opel/Vauxhall
- punching device/centering pin Ø26.0mm for VW/Seat
- punching device/centering pin Ø26.7mm for VW/Skoda
- punching device/centering pin Ø27.4mm for Skoda
- punching device/centering pin Ø28.1mm for Skoda
- punching device/centering pin Ø32.0mm for BMW
- punching device Ø32.5mm for BMW (without centering pin because of the oblique mounting position of the PDC sensor)
- punching device Ø38.9mm for VW (PLA) (without centering pin due to slanted mounting position of PLA = park assist)
- 1x 3/8" punch drive with ball bearing
- 1x tip Ø10mm
- 1 rotating head ratchet



TN

## REAR PARKING SENSOR PUNCH MASTER TOOL KIT VW (24 PCS)

OC 9124

490 €VAT Excl.

Instead of 550 €VAT Excl.\*

### Contents:

- punches: Ø18,2-18,4-26-26,5-26,7-28,1-29,3-38,9mm
- centering tools: Ø17,8-18,2-18,4-26-26,7-28,1mm
- 1 x 3/8" pulling screw with ball bearing
- 1 x drill bit Ø10mm



TN

## 5-1 DISPOSABLE PROTECTION SET (500PCS)

CO 0426

500 piece 5 in 1 Disposable protector set



Each 5 in 1 kit includes:

- 1 x seat protector
- 1 x steering wheel protection
- 1 x gearshift protection
- 1 x handbrake protection
- 1 x floor protection



NO WARRANTY

99 €VAT Excl.

Instead of 137 €VAT Excl.\*

## RENOVATION KIT FOR 2 HEADLIGHTS

RP3000

Product available for sale only in France

Provides a fast, easy and efficient headlight renovation. No tools or sanding required.

3 pre-saturated wipes allow for a complete renovation of both headlights.

- 2 cleaning wipes (one for each headlight).
- 1 finishing and protective wipe to restore the shine of the headlights.



13 €VAT Excl.

Instead of 22 €VAT Excl.\*

NO WARRANTY

## PLASTIC PRIMARY SPRAY 400ml

CO 1002

9€VAT Excl.

Instead of 9.90 €VAT Excl.\*



400 ml

NO WARRANTY

## BUMPER STRUCTURING SPRAY MEDIUM GRIT 400ml

CO 1003

10€VAT Excl.

Instead of 11 €VAT Excl.\*



400 ml

NO WARRANTY

## 300 ml OIL LEAK STOP

CO 1014

10€VAT Excl.

Instead of 12 €VAT Excl.\*



300 ml

NO WARRANTY